

HULK FASTENERS.™

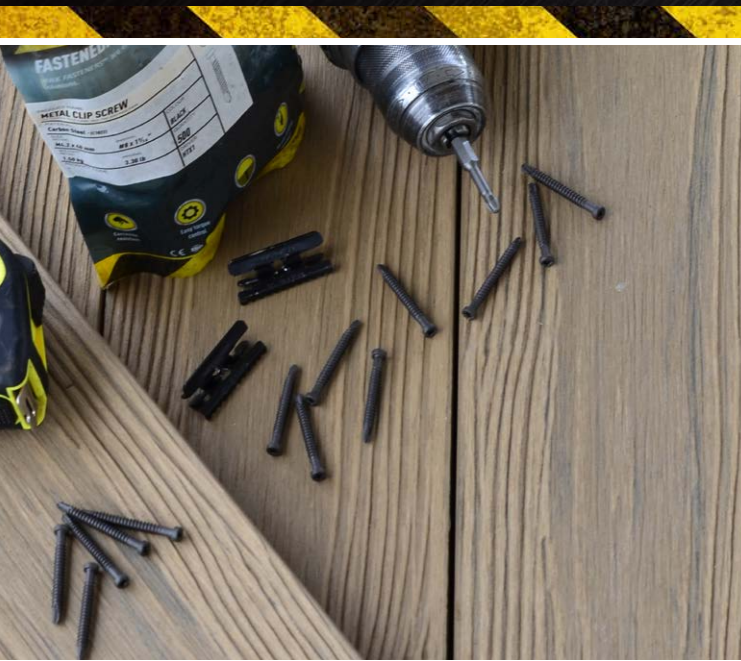

FASTENED, FOR LIFE.

www.eva-last.com



RELIABLE DECKING FASTENER SYSTEMS



Corrosion
Resistant



Colour Matched
Aesthetic



Neat Surface
Finish



Fast and Easy
Installation



No Pre-drilling
Required*

HULK Fasteners™ are purposefully designed to make composite or timber decking installations more efficient and straightforward by providing highly durable hidden fastener options that fit neatly into the edges of grooved boards, as well as a range of colour matching top fixing screws. These fasteners are created to match the warranties of the leading composite decking boards on the market, and are available in a wide variety of colours to complement the look of your decking of choice.



THE HISTORY OF HULK FASTENERS™

Eva-Last® has spent years designing, engineering, and patenting high performing composite decking and cladding that is backed by industry-leading warranties - some which offer coverage for up to 30 years. However, conventional fasteners simply have not been able to match the long-term performance of Eva-Last® composite material which, in turn, can compromise the integrity of the entire deck or cladding installation.

Through a research and design process specifically aimed at creating a range of fasteners worthy of the Eva-Last® brand, HULK Fasteners™ were conceptualised, stress-tested, and patented. They are now regarded as the best performing fasteners worldwide.

PRODUCT PRINCIPLES

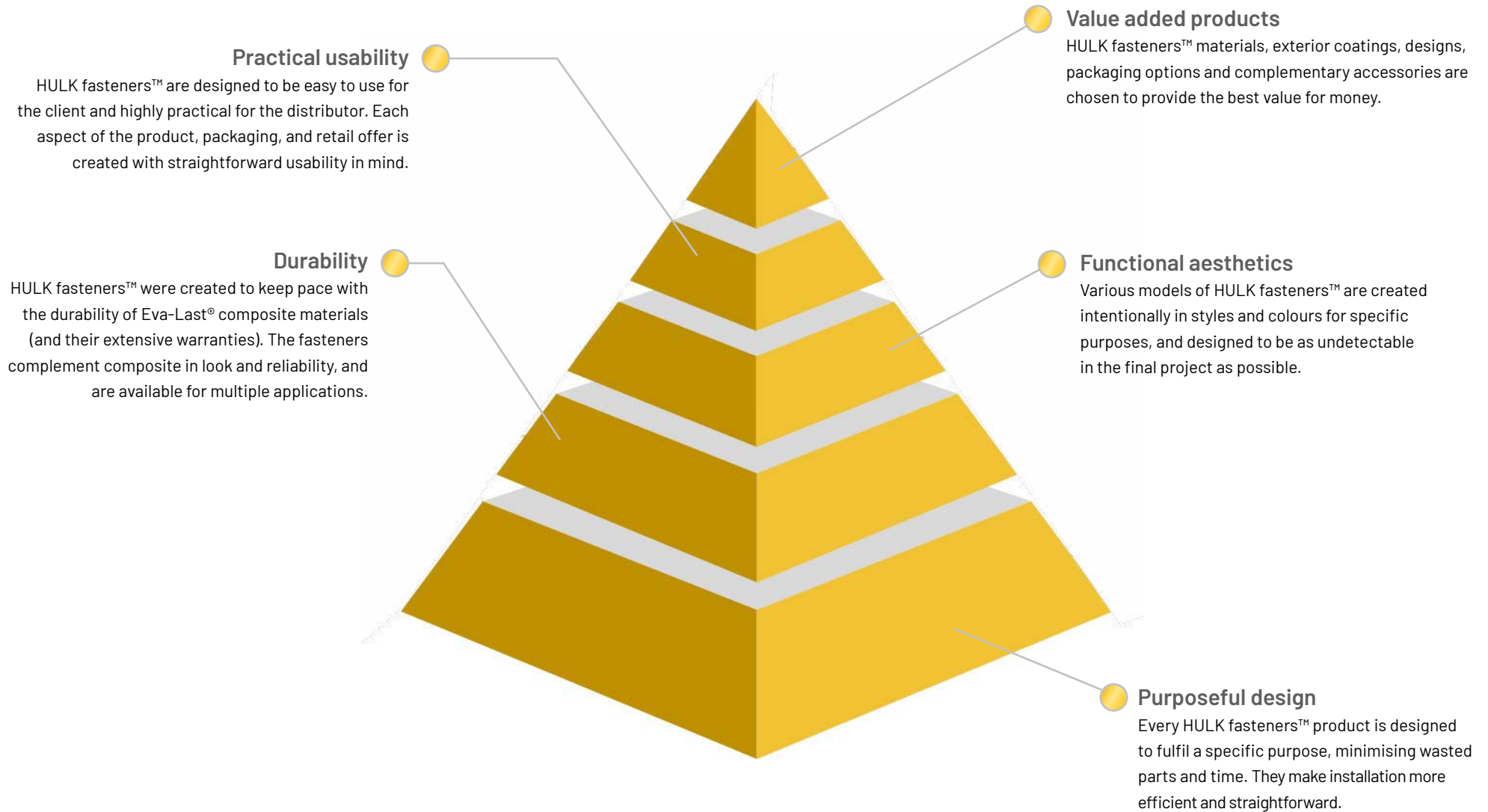

METAL FASTENERS



CS
CARBON
STEEL
C1022

METAL CLIP SCREW

Designed to fasten HULK hidden deck clips onto metal frames without having to pre-drill unless specified by decking manufacturer.

COMPATIBLE WITH
'S' SERIES CLIP AND
COLLATED CLIP



CS
CARBON
STEEL
C1022

METAL DECK SCREW

For fastening 20 - 25 mm thick composite deck boards onto metal frames without having to pre-drill unless specified by decking manufacturer.



TEK SCREW

Fixes steel to steel. Fixes metal frames to metal frames. Self-drilling tip, no pre-drilling needed.



SS
STAINLESS
STEEL
SS410

METAL TRIM SCREW

For fastening 10 - 18 mm thick composite fascia boards onto metal frames without having to pre-drill unless specified by decking manufacturer.

CS
CARBON
STEEL
10B21

DECK FASTENERS

HIDDEN DECKING CLIPS



S-SERIES



S6 CLIP S9 CLIP

For fastening grooved deck boards with a foot height of approximately 6 mm. Used with either metal or timber clip screw.



For fastening grooved deck boards with a foot height of approximately 9 mm. Used with either metal or timber clip screw.

chain™
Collated decking clip

NEW

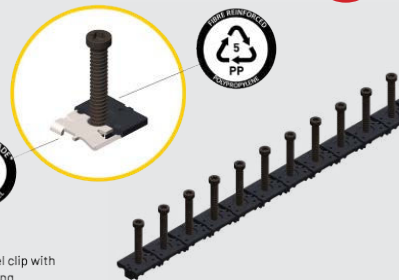

Stainless steel clip with polymer coating



Universal collated clips with preloaded screws. Available with either metal or timber clip screws.



USED ON VARIABLE BOARD HEIGHTS OF 6 mm - 12 mm

TIMBER FASTENERS

TIMBER CLIP SCREW

For fastening HULK hidden deck clips onto timber frames without having to pre-drill unless specified by decking manufacturer.

COMPATIBLE WITH
'S' SERIES CLIP AND
COLLATED CLIP



SS
STAINLESS
STEEL
SS316



C5 / A4
Marine
Grade

CS
CARBON
STEEL
C1022

TIMBER DECK SCREW

Used for fastening 20 - 25 mm thick composite deck boards onto timber frames without having to pre-drill unless specified by decking manufacturer.



SS
STAINLESS
STEEL
SS316



C5 / A4
Marine
Grade

CS
CARBON
STEEL
C1022

TIMBER FRAMING SCREW

For fastening hardwood and softwood timber in a single or double level frame application. Pan head has a built-in washer.



TIMBER TRIM SCREW

Designed to fasten 10 - 16 mm thick fascia boards onto timber frames without having to pre-drill unless otherwise specified by decking manufacturer.



SS
STAINLESS
STEEL
SS316



C5 / A4
Marine
Grade

CS
CARBON
STEEL
10B21



HOW HULK FASTENERS™ WORK

HULK fasteners™ are hidden fasteners that give decking and cladding projects a seamless finish and a reliable, long-lasting hold. Various clip and screw fastener types are designed for specific applications to produce best and most attractive results.



S-SERIES CLIP

Eva-Last® created the S-Series (Halo) clip in 2010, designed to match the life expectancy and durability of Eva-Last® composite decking materials. This product laid the foundation for the hidden fastener: no more protruding screws, no more ruined finishes, no more untidy aesthetics.

That same year, the S-Series clip was further improved to gracefully control and absorb the expansion and contraction of boards in order to ensure that no harm would come to decking or cladding boards even in climates of extreme temperature variations.

CLIP & SCREW

CLIP & SCREW FOR TIMBER FRAMES



Torpedo tip
Type 17



CLIP & SCREW FOR METAL FRAMES



Z-point tip



HULK fasteners™ were released to markets across the African continent in 2013, including the Z-point and Torpedo clip screws designed for use with timber and steel frames. These specially engineered screws are created with aesthetics in mind, and perfectly blend into their dark shaded environment.

Eva-Last® perfected the HULK fasteners™ range, optimising form and function for a reliable, long-lasting fastening solution which could complete the decking package. HULK fasteners™ are built to withstand the toughest of weather conditions.



COLLATED CLIP

In 2022, Eva-Last will launch a new hidden fastener, Chain™ collated decking clip. This clip was developed to address many of the pitfalls of current deck installations and fastening systems.



chain™
Collated decking clip

FEATURES AND BENEFITS



MORE EFFICIENT INSTALLATION

Collated system comes pre-loaded with screws for quicker installation



UNIVERSAL APPLICATION

Works with timber & composite boards of variable thickness & groove depths



DURABLE

Stainless steel clip with a protective polymer coating for extended outdoor longevity



STRENGTH IN SIZE

Proven strength in uplift holding power & preventing lateral movement of boards



INNOVATIVE ENGINEERING

Cost-effective use of materials without affecting grip strength or overall clip performance



EASIER POST-INSTALLATION ACCESS

More convenient post-installation board removal with direct overhead fastener access

Chain™ collated clips save you time and money by streamlining installation with preloaded stainless steel clips that offer cutting-edge performance for the entire lifespan of your deck and complement the overall look of your project.

chain™

Collated decking clip

Stainless steel clip with
polymer coating

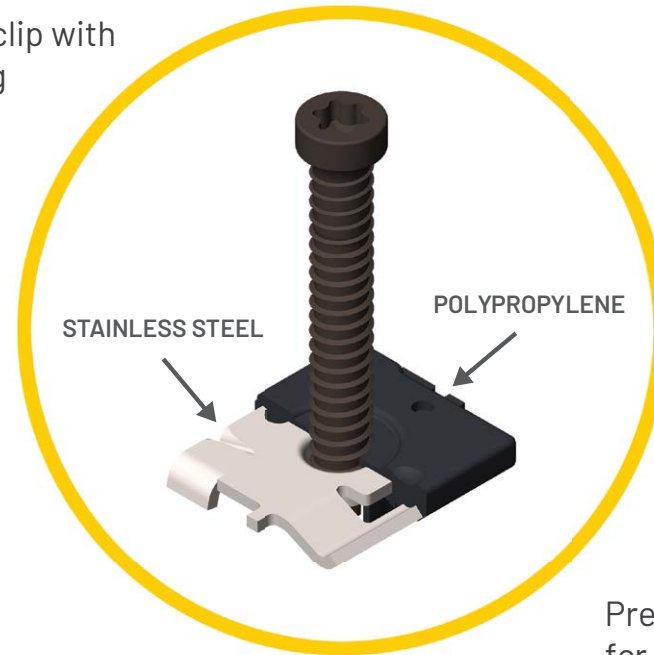

Preloaded with screw
for ease of installation

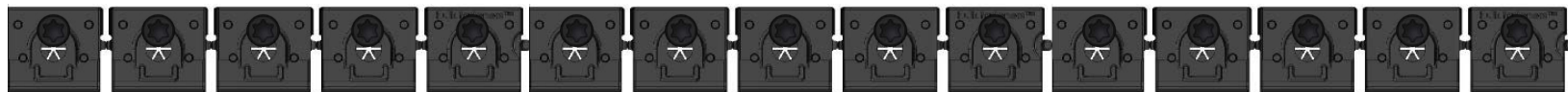

Chain™ collated clips are preloaded with screws for a more efficient installation and designed to work with both timber and composite boards of variable thickness and with timber or metal frames. The durable stainless steel clips are equipped with a long-lasting polymer coating and have proven strength in uplift holding power to prevent the lateral movement of boards. The innovative engineering of the collated clip creates a more cost-effective fastener with reliable integrity, easier post-installation board removal, and a discreet appearance that complements the overall look of your project.

CHAIN™ HAND TOOL

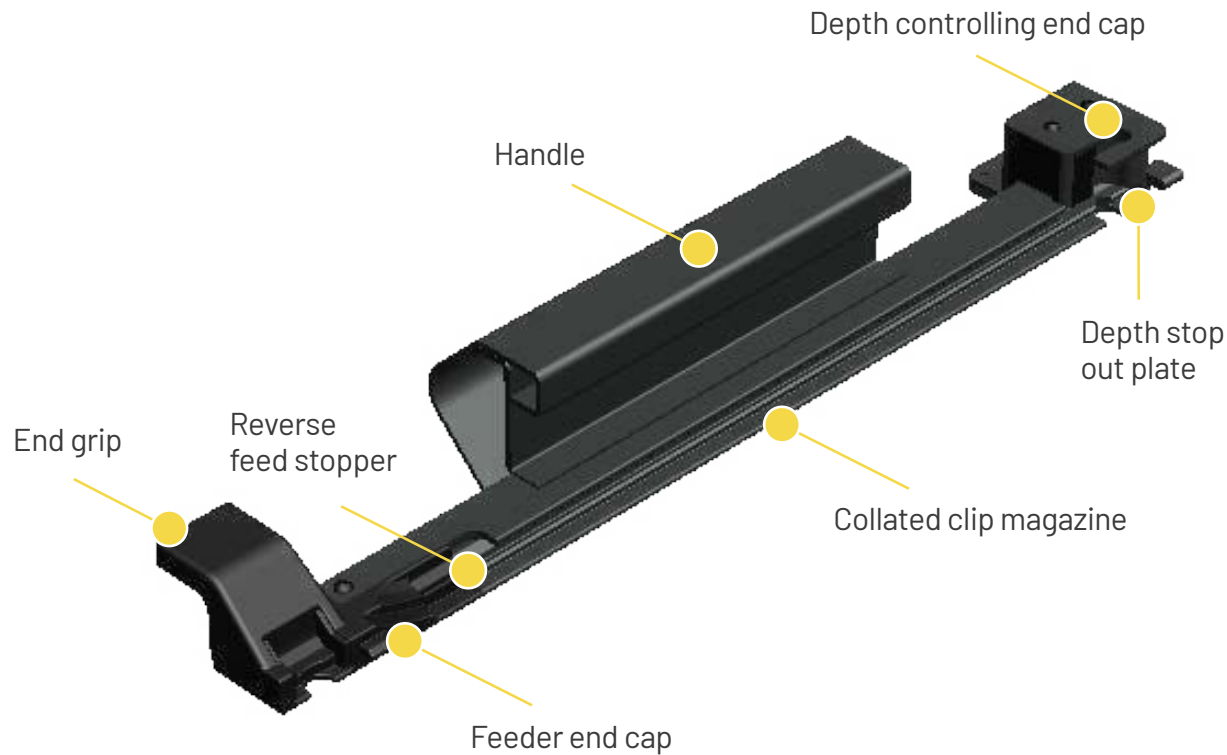

MAXIMISE DECKING INSTALLATION EFFICIENCY

The Chain™ hand tool adds value to the Chain™ collated clip system by maximising installation efficiency. The hand tool creates precise fastening thanks to its built-in depth control system that eliminates installation errors and weak connections. The hand tool is compatible with a wide range of composite and timber board sizes, ergonomically designed for ease of use, and made from high quality materials for long-lasting reliability.

COLOUR MATCHED TOP FIXING SCREWS

FOR METAL FRAMES

Available in stainless steel and carbon steel

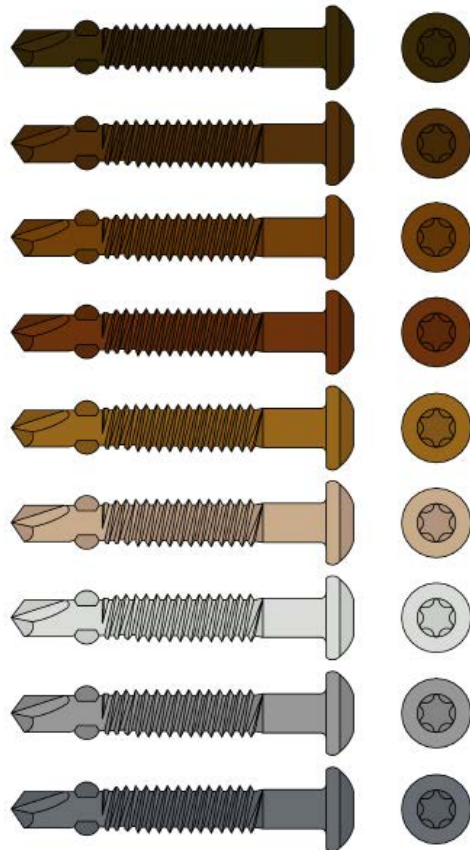

DARK BROWN

BROWN

LIGHT BROWN

RED BROWN

TAN BROWN

BEIGE

WHITE

LIGHT GREY

DARK GREY

FOR TIMBER FRAMES

Available in stainless steel and carbon steel

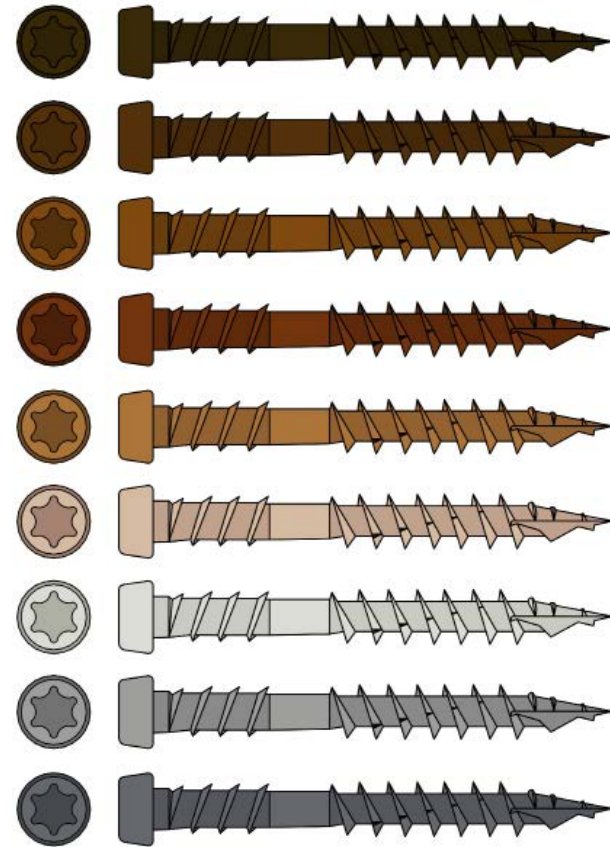

HULK fasteners™ composite deck and trim screws are available in nine different colours designed to match and blend in with decking boards from all leading composite decking manufacturers. Choose the colour that matches your decking boards for a discreet final look. Please check your regional availability of screw colours.

COMPOSITE DECK SCREWS

CDS - composite deck screw

For fastening (top-fixing) to timber frames



Carbon steel: fully coated

Available in beige, brown, light brown, dark brown, red brown, dark grey, light grey, and white

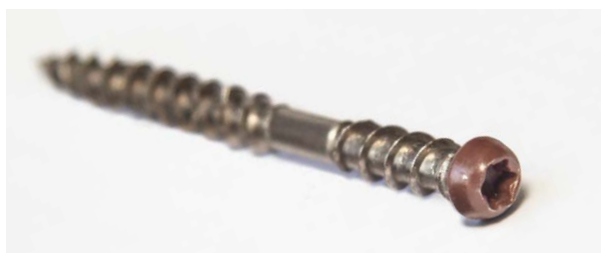

Stainless steel: 316 head coated

Available in beige, brown, light brown, dark brown, red brown, dark grey, light grey, and white



MDS - metal deck screw

For fastening (top-fixing) to metal frames



Carbon: 2000 hour coating

Available in beige, brown, light brown, dark brown, red brown, dark grey, light grey, and white

In response to growing demand, Eva-Last® patented a unique line of composite deck screws in a range of colours to match Eva-Last® and third-party composite decking products in 2016. HULK fasteners™ could now be used to improve the look and functionality of an even greater range of decking products.

COMPOSITE DECK SCREWS

SCREW FEATURES

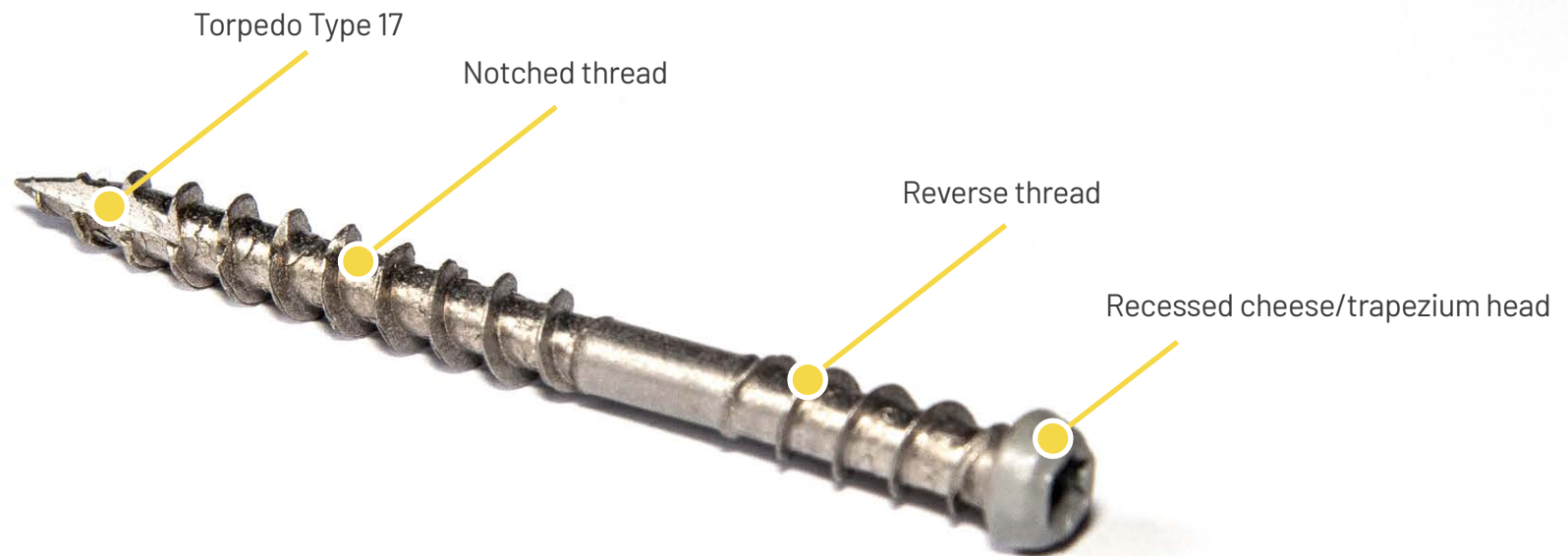

HULK fasteners™ feature top fixing screws that are specifically designed with a new trapezium head to prevent the build-up of debris and displace less material when being driven into a frame or deck board. The large head area also acts as a washer to better hold the board in position.

Reverse thread ingeniously removes materials around the screw shaft so that the expansion and contraction of the board under various weather conditions will not cause the screw to be put under stress. A wider notched thread also assists in removing material optimally, making HULK fasteners™ ideal for use with composite products on timber or metal frames.

COMPOSITE TRIM SCREWS

M5.5 x 48 mm composite trim screws
for use with timber frames



M5.5 x 35 mm composite trim screws
for use with metal frames

Choose the right trim screw to suit your substructure material.

HULK fasteners™ trim screws are specially engineered to fasten composite trim boards or fascia boards to a structure. Choose between the composite trim screws designed to work with timber substructures and composite trim screws created to work with metal substructures. Each type of trim screw offers unique dimensions for use with either wood or metal framing, but both types of trim screws are available in stainless steel and carbon steel and in a wide range of colours to match your composite fascia or trim boards.

FRAME SCREWS



Timber frame screw for wood structures

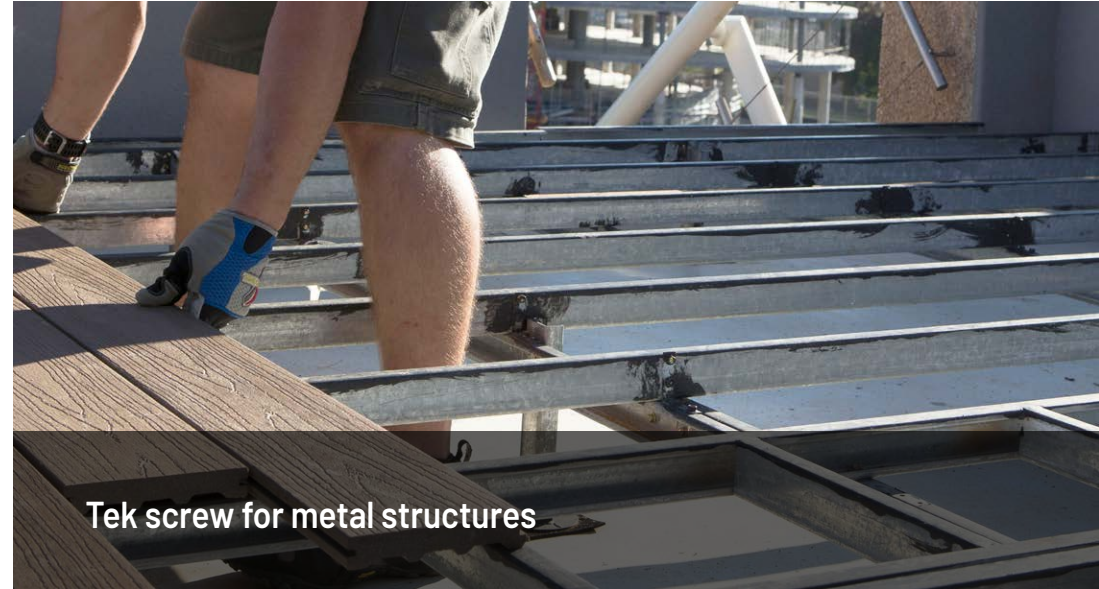

Tek screw for metal structures



Timber frame screws

Carbon: Zinc epoxy coated 2000 hours
80 mm and 100 mm

Available in golden colour to match yellow softwoods and provide optimal corrosion resistance



Tek screw

Carbon: 4µm thick coating - minimum 45µm mechanical zinc galvanised coating



WHY USE HULK FASTENERS™?

HULK fasteners™ are available in a variety of tough and durable corrosion-resistant materials to provide reliable performance in even the toughest of climates. Their range of colours is thoughtfully designed to add to the overall look of your project and their cutting-edge engineering provides a robust fastener that holds better and lasts longer than the competition.

GLOBAL CORROSION ZONES

HULK fasteners™ thrive in even the most extreme climates.

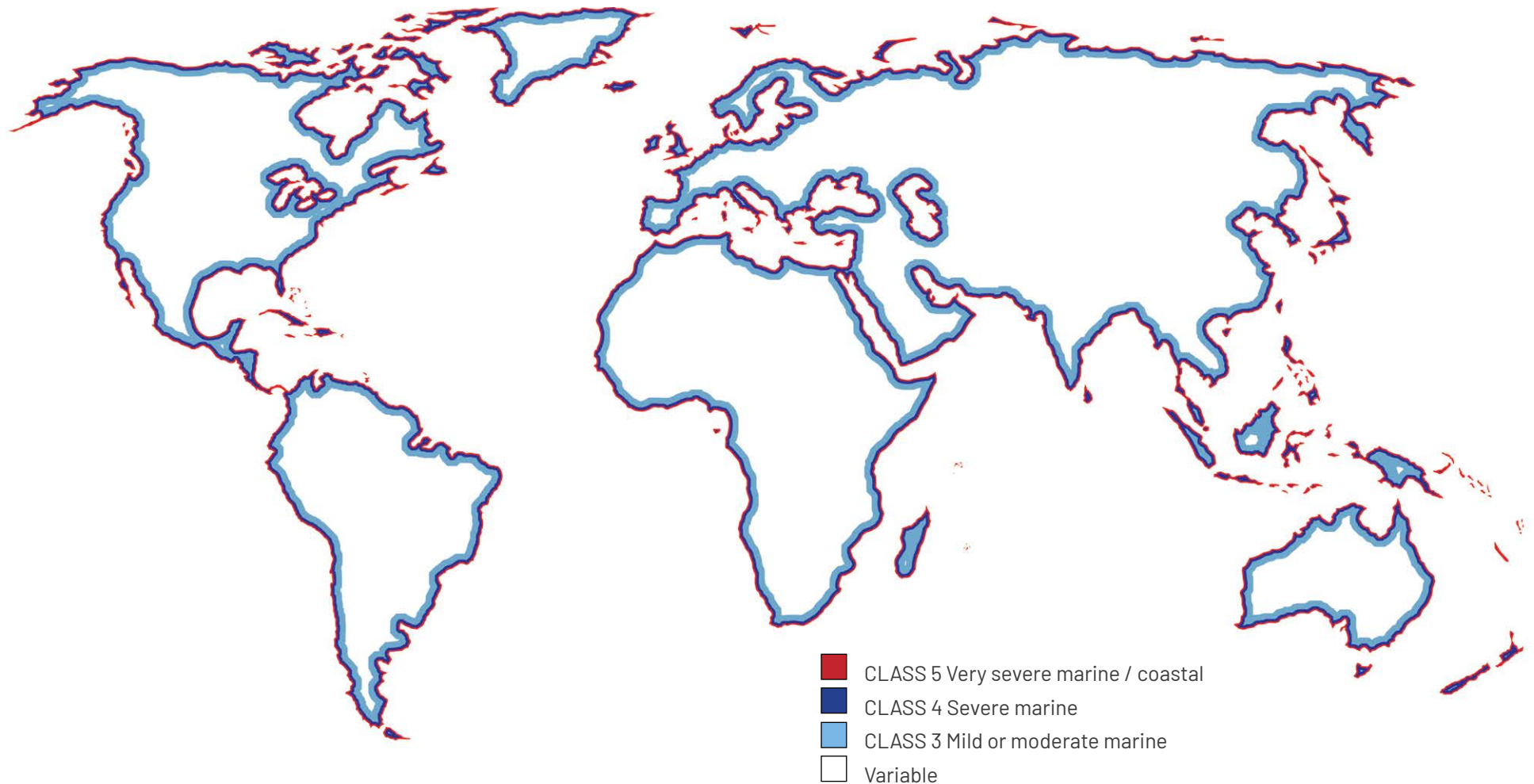

HULK fasteners™ are built to withstand corrosion. HULK fasteners™ now offer a full range of C5 / A4 Marine-grade stainless steel screws, recommended for Class 5 regions. Stainless or nano-coated carbon steel screws are best for Class 4 regions. All HULK fasteners™ perform optimally in Class 3 and variable regions.

WITHSTANDS THE WEATHER

HULK FASTENERS™ PROVIDE RELIABLE OUTDOOR FASTENING.

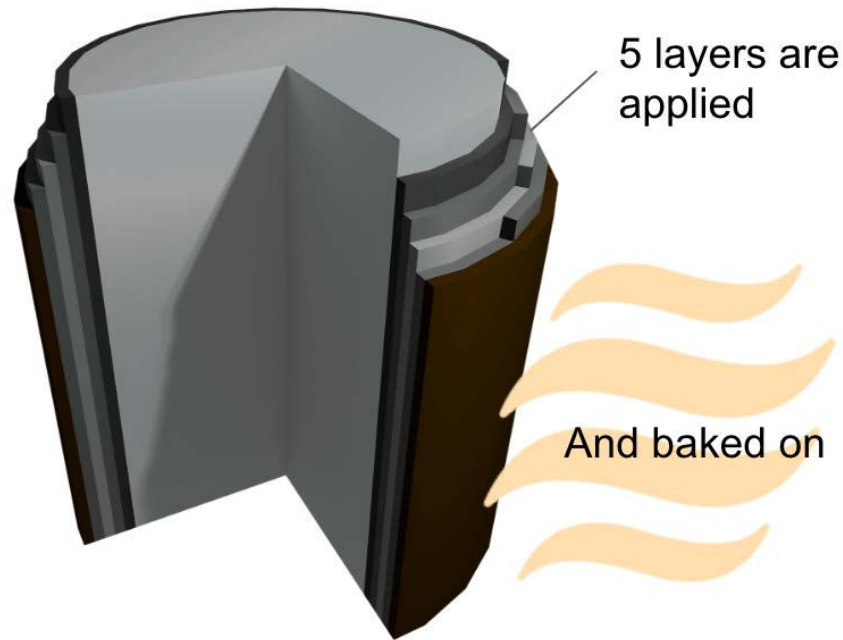

Base layer + five layers of colour

The base of a HULK fasteners™ is coated five times with colour matched engineered zinc epoxy resin, designed specifically for outdoor use.



15-year lifespan

HULK fasteners™ offer a 15-year lifespan in C4 conditions as per European and international standards.

HULK fasteners™ feature a strong base coated by five layers of colour, which perfectly match the natural-looking colours from the Eva-Last® composite range. This allows the fastener to blend in with the decking board of your choice and create a seamless final look.

STARTER & EXPANSION PACKS



S-SERIES clip and screw combo packs



CHAIN™ collated clip packs



Standalone clip packs



Standalone screw packs

CHAIN™ collated clips come with screws preloaded and are available in convenient packs of 900 units (60 collations).

The HULK fasteners™ S-Series clip system is available in convenient starter and expansion packs of clip and screw combinations, or as standalone clip or screw packs.

HULK MERCHANDISING RACKS

HULK Fasteners™ retail displays available on request



Plastic containers now replaced with doy bags for ease of merchandising.

Associated tools may be co-merchandised on the HULK Fasteners™ display.

HULK fasteners™ merchandising racks are designed to be compact but still grab the attention of passing customers for maximum exposure. The adjustable peg board allows for easy expansion of ranges on sale – adaptable enough to adjust to the unique layout and space of any store. Each forklift-friendly stand is sturdy enough to be lifted, moved, and placed without needing to be repacked.

RETAIL MERCHANDISING



HULK FASTENERS™

FASTENER FAMILIES

Corrosion Resistant

Colour Matched Aesthetic

Neat Surface Finish

Fast and Easy Installation

No Pre-drilling Required*

FASTENER FAMILY	DESCRIPTION	MATERIALS	INSTALLATION
FUN FACT	Certain stainless steels are magnetic. Like most of the 400 series stainless steel you will find in our clips and stainless steel metal deck fasteners.	CS CARBON STEEL C1022	
METAL CLIP SCREW	Designed to fasten HULK fasteners Hidden deck clips onto timber frames without having to pre-drill. Unless specified by decking manufacturer, suitable for softwoods and most hardwood frames. Pre-drilling may be required in denser hardwood timbers.	CS CARBON STEEL C1022	
DECK FASTENERS	HIDDEN DECK CLIPS S6 CLIP S9 CLIP For fastening grooved deck boards with a foot height of approximately 8.0 mm.	CS CARBON STEEL C1022	
TIMBER CLIP SCREW	For fastening HULK Hidden deck clips onto timber frames without having to pre-drill. Unless specified by decking manufacturer, suitable for softwoods and most hardwood frames. Pre-drilling may be required in denser hardwood timbers. Stainless steel - SS316. Epoxy coated ash brown or black.	CS CARBON STEEL C1022 SS STAINLESS STEEL SS316	
METAL DECK SCREW	For fastening 20-25 mm thick composite deck boards onto metal frames without having to pre-drill. Unless specified by decking manufacturer, suitable for deck boards onto metal frames of up to 2.0mm without having to pre-drill, thereafter it is advisable to pre-drill. Detachable remainer wing is only operational in steel upward of 0.8 mm thick. For a tight grip ensure that the wing has broken off.	CS CARBON STEEL C1022	
TIMBER DECK SCREW	Used for fastening 20-25 mm thick composite deck boards onto timber frames without having to pre-drill unless specified by decking manufacturer. Suitable for softwood and most hardwood frames. Pre-drilling may be required for dense hardwood timbers.	CS CARBON STEEL C1022 SS STAINLESS STEEL SS316	
UNIVERSAL COLLATED CLIPS	Universal collated clips with predrilled screws. Available in both metal and timber screws. Suitable for deck boards of various groove depths from 0.8mm to 12.0 mm, as well as substrate. This universal clip allows for quick and easy installation using a custom designed hand tool. No need for pre-drilling, unless specified by the deck manufacturer.	CS CARBON STEEL C1022	
TEK SCREW	Fixes steel to steel. Fixes metal frames to metal frames. Self-drilling tip, no pre-drilling needed.	CS CARBON STEEL C1022	
TIMBER FRAMING SCREW	For fastening hardwood and softwood timber in a single or double level frame application. Pan head has a built in washer.	CS CARBON STEEL C1022 SS STAINLESS STEEL SS316	
METAL TRIM SCREW	For fastening 10-18 mm thick composite fascia boards onto metal frames without having to pre-drill. Unless specified by decking manufacturer, suitable for deck boards onto metal frames of up to 2.0mm without having to pre-drill, thereafter it is advisable to pre-drill. Detachable remainer wing is only operational in steel upward of 1.2 mm thick. For a tight grip ensure that the wing has broken off.	CS CARBON STEEL C1022 SS STAINLESS STEEL SS316	
FASCIA FASTENERS	Designed to fasten a 10 to 18 mm thick composite fascia boards onto timber frames without having to pre-drill. Unless otherwise specified by decking manufacturer, thereafter it is advisable to pre-drill the composite only. Suitable for softwoods and most hardwoods. Use two or more screws per fastener, the 30 mm from the edge of boards at appropriate spans, in accordance with trim manufacturers guidelines.	CS CARBON STEEL C1022 SS STAINLESS STEEL SS316	
TIMBER TRIM SCREW	Designed to fasten a 10 to 18 mm thick composite fascia boards onto timber frames without having to pre-drill. Unless otherwise specified by decking manufacturer, thereafter it is advisable to pre-drill the composite only. Suitable for softwoods and most hardwoods. Use two or more screws per fastener, the 30 mm from the edge of boards at appropriate spans, in accordance with trim manufacturers guidelines.	CS CARBON STEEL C1022 SS STAINLESS STEEL SS316	

*All fastener spans are to be in accordance with deck suppliers recommendations.

Fastened for life.

A PRODUCT BY **EVA-LAST**

> C3 / A4
Very High corrosion

C4
High corrosion

C3
Medium Corrosion

Contact a professional to determine the atmospheric conditions of your site.

Identifying between Stainless Steel or Carbon Steel on metal and timber trim screws:

STAINLESS STEEL CARBON STEEL

Stainless steel fasteners that are fully coated will have a small spot located on the head.

HULK fasteners™ brochures and poster accompany the merchandising rack and are attractive, informative as well as easy to understand with comprehensive information on the relevant HULK Fasteners™ product range.

HIDDEN FASTENER PRODUCT OVERVIEW

CLIPS AND CLIP SCREWS

CHAIN™ collated clip



The CHAIN™ collated clip is used for fastening composite or timber decking onto timber or metal frames without having to pre-drill unless specified by decking manufacturer. Collations have 15 clips in a strip and are all preloaded with clip screws for use with either timber or metal frames.

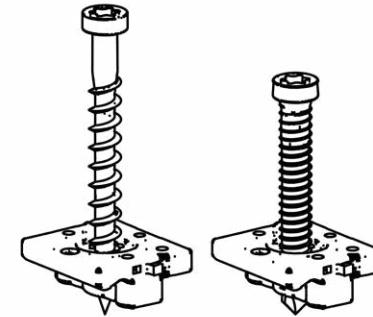

Description	Metric	Imperial	Coating	g/single unit	Clip material	Bit
CHAIN™ with screw for timber	16.5 x 6.5 x 18.5 mm clip M4.2 x 40 mm screw	5/8" x 1/4" x 3/4" clip #8 x 1 3/4" screw	PE polymer	4.46	SS316 with PE coating	Depth controller T15
CHAIN™ with screw for metal	16.5 x 6.5 x 18.5 mm clip M4.2 x 31 mm screw	5/8" x 1/4" x 3/4" clip #8 x 1 1/4" screw	PE polymer	71.1	SS316 with PE coating	Depth controller T15

CHAIN™ hand tool



Use the CHAIN™ hand tool in conjunction with CHAIN™ collated clips. Continuous clip collation strips can be loaded into the hand tool via a slot opening. The hand tool is packaged and sold separately from collated clip packs.

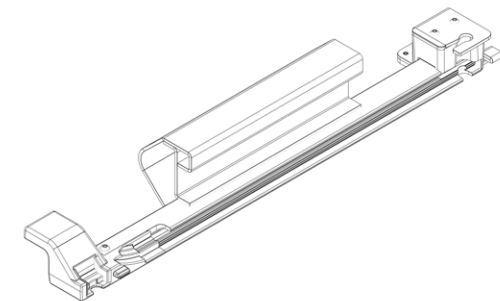

Description	Metric	Imperial	Coating	g/Fastener	Material	Bit
CHAIN™ Hand tool	375 x 60 mm	14 3/4" x 2 1/4"	Powder coated	N/A	Aluminium body, Nylon caps	N/A

HIDDEN FASTENER PRODUCT OVERVIEW

CLIPS AND CLIP SCREWS

S-SERIES hidden fastener ●

Use the S9 fastener for a foot height between 8.5 and 9.25 mm on metal or timber structures.
Use the S6 fastener for a foot height between 5.5 and 6.25 mm on metal or timber structures.

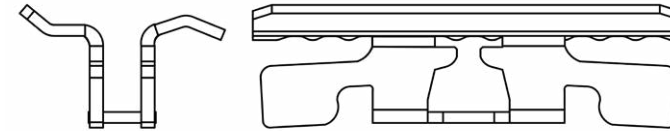

Description	Metric	Imperial	Coating	g/Fastener	Material
S9	18 x 38 x 9 mm	3/4" x 1 1/2" x 3/8"	Enamel	6	SS430
S6	18 x 38 x 6 mm	3/4" x 1 1/2" x 1/4"	Enamel	6	SS430

TIMBER clip screw ●

Use the timber clip screw for fastening HULK hidden fasteners onto timber frames without having to pre-drill unless specified by decking manufacturer. It is suitable for softwood and most hardwoods frames. Pre-drilling may be required for dense hardwood frames.

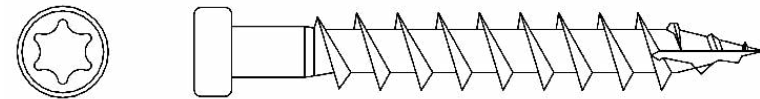

Description	Metric	Imperial	Coating	g/Fastener	Material	Bit
Carbon steel	4.2 x 42 mm	#8 x 1 1/2"	Zinc-epoxy coating	2.00	C1022	T 15
Stainless steel	4.2 x 42 mm	#8 x 1 1/2"	Zinc-epoxy coating	2.00	SS316	T 15

METAL clip screw ●

Use the metal clip screw for fastening HULK hidden fasteners onto metal frames without having to pre-drill unless specified by decking manufacturer. It is suitable for metal frames between 0.8 to 2.5 mm. Pre-drilling may be required with gauges greater than 2.0 mm.

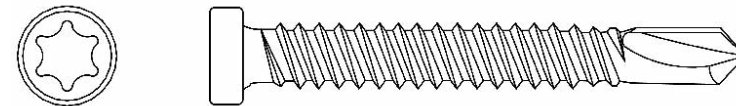

Description	Metric	Imperial	Coating	g/Fastener	Material	Bit
Carbon steel	4.2 x 31 mm	#8 x 1 1/2"	Zinc-epoxy coating	2.00	C1022	T 15

MATCHED FASTENER PRODUCT OVERVIEW

COMPOSITE SCREWS

COMPOSITE deck screw

Use the composite deck screw for fastening 20 to 25 mm thick composite or timber deck boards onto timber frames without having to pre-drill unless specified by decking manufacturer. It is suitable for softwood and most hardwoods frames. Pre-drilling may be required for dense hardwood frames.

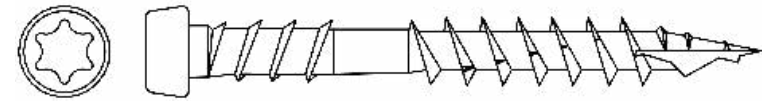

Description	Metric	Imperial	Coating	g/Fastener	Material	Bit
Carbon steel	5.0 x 60 mm	#10 x 2- 1/2"	Zinc-epoxy coating	5.85	C1022	TX 20
Stainless steel	5.0 x 60 mm	#10 x 2- 1/2"	Zinc-epoxy coating	5.85	SS316	TX 20

METAL deck screw

Use the metal deck screw for fastening 20 to 25 mm thick composite or timber deck boards onto metal frames without having to pre-drill. It is suitable for metal structures of thicknesses up to 2.0 mm. Thereafter it is advisable to pre-drill. The detachable reamer wing is only operational in steel upward of 0.8 mm thick.

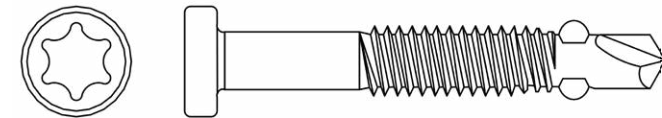

Description	Metric	Imperial	Coating	g/Fastener	Material	Bit
Carbon steel	4.8 x 44.45 mm	#10-20 x 1-3/4"	Zinc-epoxy coating	5.85	C1022	TX 20

All composite deck top fixing screws are available in nine colour options.

MATCHED FASTENER PRODUCT OVERVIEW

TRIM SCREWS

TIMBER trim screw

Use the timber trim screw for fastening 10 to 18 mm thick composite or timber fascia boards onto timber frames without having to pre-drill unless specified by decking manufacturer. It is suitable for softwood and most hardwoods frames. Pre-drilling may be required for dense hardwood frames.

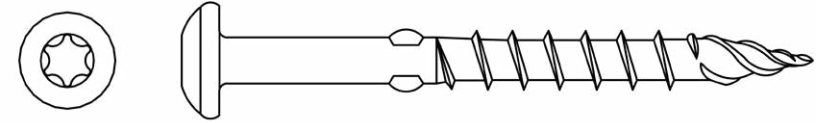

Description	Metric	Imperial	Coating	g/Fastener	Material	Bit
Carbon steel	M 5.5 x 48 mm	1/4" x 1 7/8"	2000 Hour	N/A	10B21	TX 25
Stainless steel	M 5.5 x 48 mm	1/4" x 1 7/8"	Head	N/A	SS410	TX 25

METAL trim screw

Use the metal trim screw for fastening 10 to 20 mm thick composite or timber fascia boards onto metal frames without having to pre-drill. It is suitable for metal structures of thicknesses up to 2.0 mm. Thereafter it is advisable to pre-drill. The detachable reamer wing is only operational in steel upward of 1.2 mm thick.

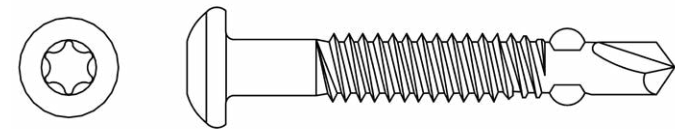

Description	Metric	Imperial	Coating	g/Fastener	Material	Bit
Carbon steel	M 5.5 x 35 mm	1/4" x 1 3/8"	2000 Hour	N/A	10B21	TX 25
Stainless steel	M 5.5 x 35 mm	1/4" x 1 3/8"	1498 Hour	N/A	SS410	TX 25

All composite deck top fixing trim are available in nine colour options.

PRODUCT OVERVIEW

FRAME & TIMBER SCREWS

TIMBER frame screw ●

Use the timber frame screw for fastening timber beams directly to one another. It is suitable for use with all structural timber.

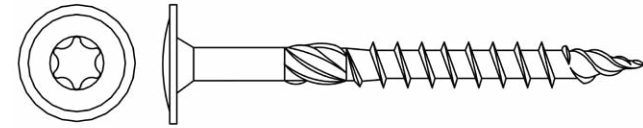

Description	Metric	Imperial	Coating	g/Fastener	Material	Bit
Carbon steel	6.0 x 80 mm	#12 x 3 5/32"	2000 Hour	12	C1022	TX 30
Carbon steel	6.0 x 100 mm	#12 X 4"	2000 Hour	14	C1022	TX 30

METAL frame screw ●

Use the metal frame screw for fastening metal and steel frames to one another.

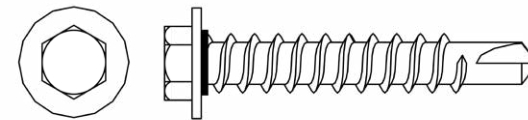

Description	Metric	Imperial	Coating	g/Fastener	Material	Bit
Carbon steel	5.0 x 25 mm	#10 x 1"	4u coating	4.5	C1022	#13



 **HULK** FASTENERS.

FASTENED, FOR LIFE.

THANK YOU

Discover more at www.eva-last.com

A PRODUCT BY **EVA-LAST**[®]
INSPIRED BY NATURE, DESIGNED FOR LIFE.